

Front view

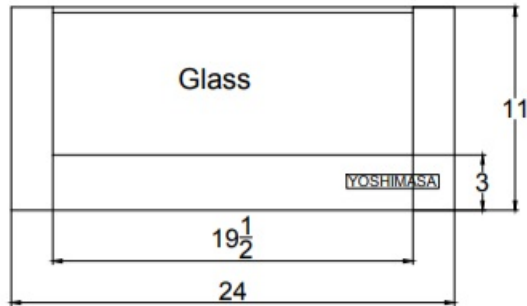

Right side view

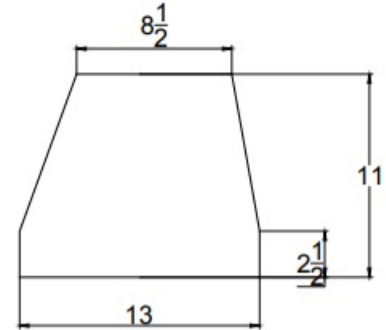

Rear view

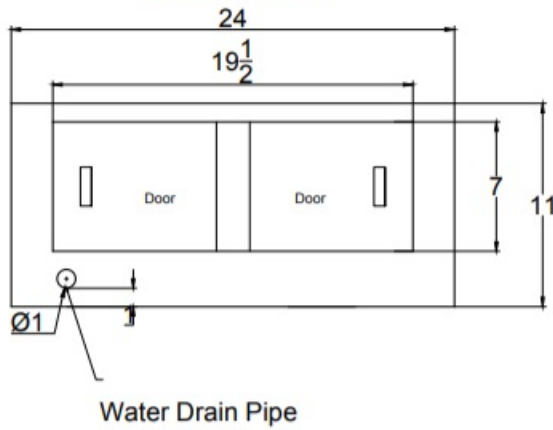

NUDO-OYSTER-2MC

Unit

Inch

Scale

1:1